

LEAD-IN SLEEVES

Kanthal SL ceramic sleeves are available for installing rod elements through furnace side walls.

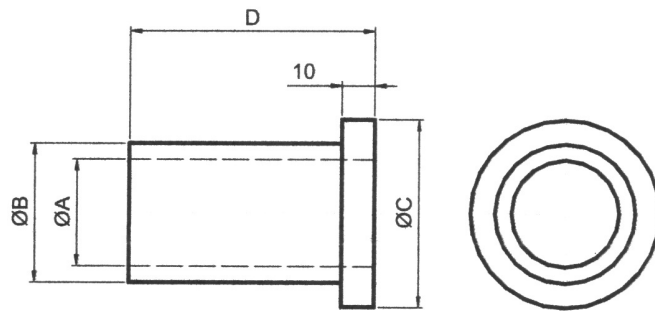

Pattern	\varnothing Element	$\varnothing A$	$\varnothing B$	$\varnothing C$	D
SL10	10	13	18	28	75
SL14	12 & 14	18	26	36	75
SL20	16,18 & 20	22	31	40	75
SL22	22	27	37	50	75
SL29	25 & 29	33	43	58	75
SL32	32	37	47	62	75
SL35	35	41	53	68	75
SL38	38	44	56	71	75
SL45	45	50	62	77	75
SL55	55	58	70	85	150

All dimensions in mm. Other lengths available on request.

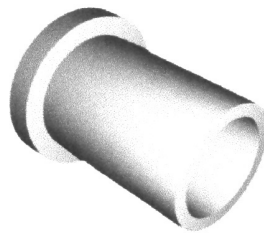

SL Sleeve

LB BLOCKS

For vertical installation of U and CU type elements.

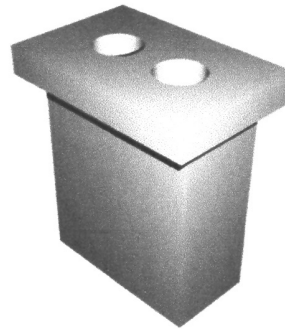
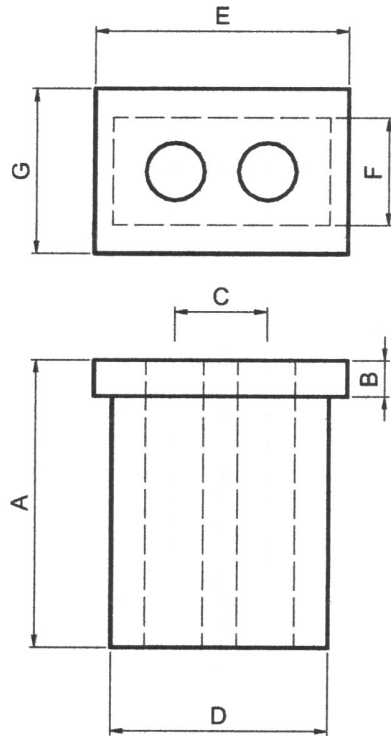

LB Block

Pattern*	Ø Element	A	B	C	D	E	F	G
LB20/xxxx	20	200	25	38	85	110	45	75
LB25/xxxx	25	200	25	52	115	150	60	95
LB32/xxxx	32	225	25	64	150	175	75	115
LB38/xxxx	38	225	25	89	175	210	90	130

* xxxx = Material grade either 1250°C, 1400°C, 1500°C
e.g. LB25/1400 for 25mm diameter element, 1400°C material

LB Block prices available on request.

For guidance on horizontal installation of Kanthal Multi-Leg elements, contact your local representative or Technical Support.

CLIPS

Aluminium braids can be fixed to elements using H Clips or, if space is limited, C Clips. A special tool (CT) is needed to fit C Clips.

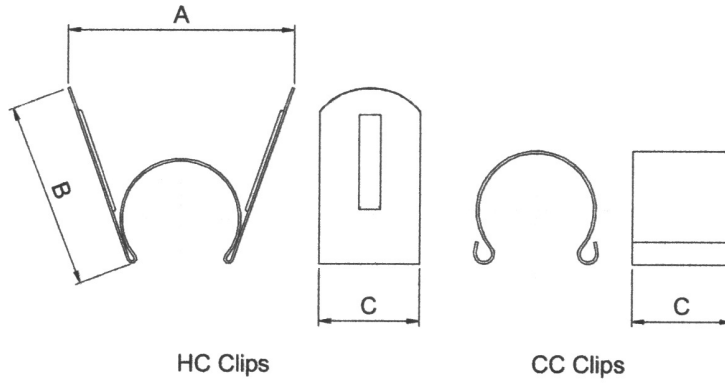

Pattern	Ø Element	A	B	C	
HC10	CC10	10	45	30	13
HC11	CC11	11 & 12	48	35	13
HC14	CC14	14	57	40	13
HC16	CC16	16	57	42	19
HC20	CC20	18, 19, 20	66	50	19
HC22	CC22	22	66	50	19
HC25	CC25	25	75	60	32
HC32	CC32	29 & 32	85	60	32
HC35	CC35	35	85	60	32
HC38	CC38	38	95	72	32
HC45	CC45	45	110	100	32
-	CC55	55	120	115	32
-	CT1	up to Ø16			
-	CT2	Ø18 and above			

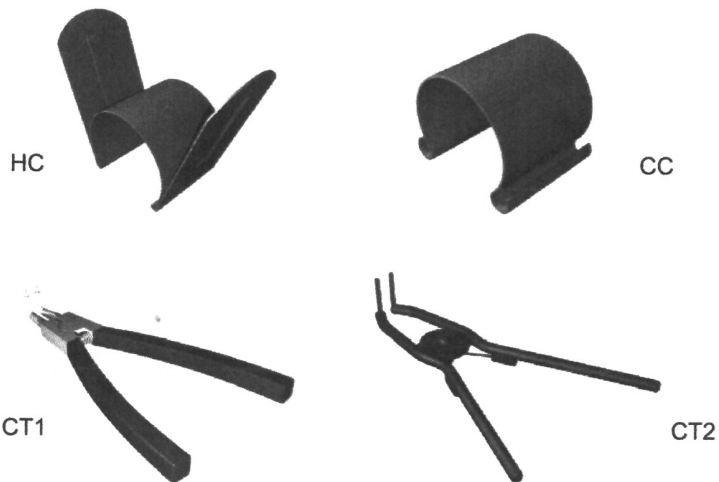

CLAMPS

Where excessively high temperatures are unavoidable, such as where sealed terminal boxes are used, the use of Type G or Type D clamps is recommended.

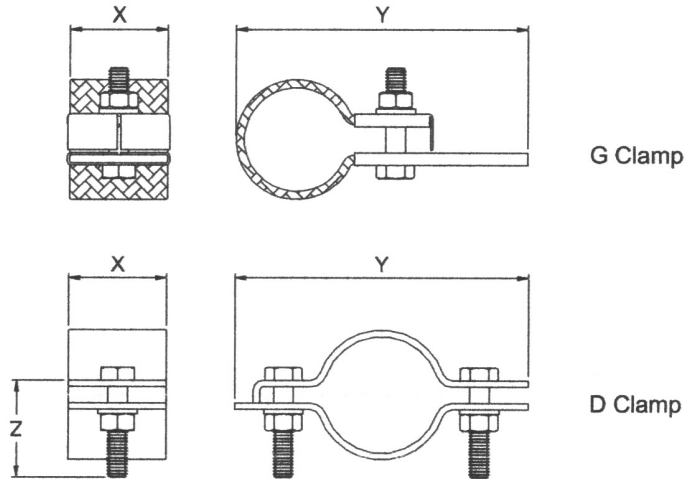

Ø Element	Pattern	X	Y	Pattern	X	Y	Z
10	G10	10	45				
12	G13	15	50				
14	G14						
16	G16	15	55				
18	G18						
20	G20	20	60	D20	30	75	25
22	G22						
25	G25	30	85	D25	30	75	25
28	G28						
32	G32	30	90	D32	30	90	30
38	G38	30	100	D38	30	100	30
45	G45	30	100	D45	30	110	30
55	G55	35	120	D55	30	120	30

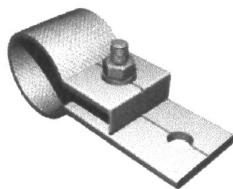

G Clamp

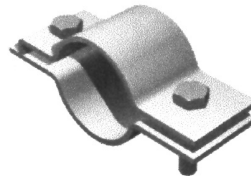

D Clamp

TYPE D-BRAIDS

For element to element connections (series). Attach with HC or CC clips, or Type D clamps (D2 braids only).

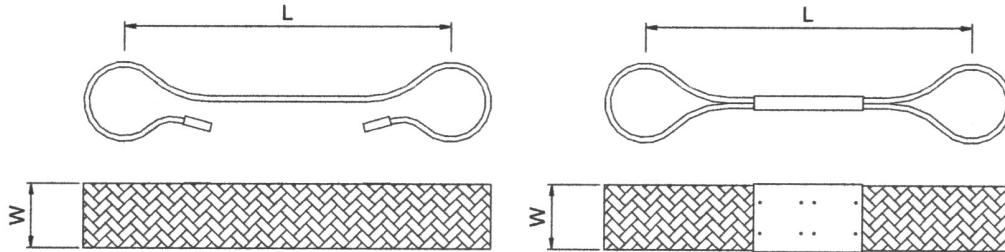

Element Ø10-Ø14, W = 10mm		Element Ø38-Ø45, W = 35mm	
Pattern	L	Pattern	L
D1/10/50	50	D1/35/50/10	50
D1/10/100	100	D1/35/100/10	100
D1/10/150	150	D1/35/150/10	150
D1/10/200	200	D1/35/200/10	200
D1/10/250	250	D1/35/250/10	250
D1/10/300	300	D1/35/350/10	300
D1/10/350	350	D1/35/350/10	350
D1/10/400	400	D1/35/400/10	400
D1/10/450	450	D1/35/450/10	450

Element Ø16-Ø22, W = 20mm		Element Ø38-Ø45, W = 30mm	
Pattern	L	Pattern	L
D1/20/50	50	D2/30/50	50
D1/20/100	100	D2/30/100	100
D1/20/150	150	D2/30/150	150
D1/20/200	200	D2/30/200	200
D1/20/250	250	D2/30/250	250
D1/20/300	300	D2/30/300	300
D1/20/350	350	D2/30/350	350
D1/20/400	400	D2/30/400	400
D1/20/450	450	D2/30/450	450

Element Ø25-Ø35, W = 30mm		Element Ø45-Ø55, W = 35mm	
Pattern	L	Pattern	L
D1/30/50	50	D2/35/50	50
D1/30/100	100	D2/35/100	100
D1/30/150	150	D2/35/150	150
D1/30/200	200	D2/35/200	200
D1/30/250	250	D2/35/250	250
D1/30/300	300	D2/35/300	300
D1/30/350	350	D2/35/350	350
D1/30/400	400	D2/35/400	400
D1/30/450	450	D2/35/450	450

Pattern Description: D1/20/250 = Type/Width mm (W)/Length mm (L)
Other sizes available on request.

TYPE S-BRAIDS

For connecting elements to busbars or terminal posts. Attach with HC or CC clips, or Type D clamps (S2 braids only).

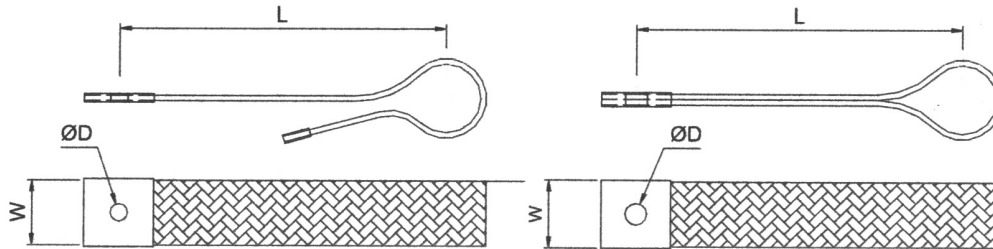

Element Ø10-Ø14, W = 10mm		Element Ø38-Ø45, W = 35mm	
Pattern	L	Pattern	L
S1/10/50/6	50	S1/35/50/10	50
S1/10/100/6	100	S1/35/100/10	100
S1/10/150/6	150	S1/35/150/10	150
S1/10/200/6	200	S1/35/200/10	200
S1/10/250/6	250	S1/35/250/10	250
S1/10/300/6	300	S1/35/350/10	300
S1/10/350/6	350	S1/35/350/10	350
S1/10/400/6	400	S1/35/400/10	400
S1/10/450/6	450	S1/35/450/10	450

Element Ø16-Ø22, W = 20mm		Element Ø38-Ø45, W = 30mm	
Pattern	L	Pattern	L
S1/20/50/8	50	S2/30/50/10	50
S1/20/100/8	100	S2/30/100/10	100
S1/20/150/8	150	S2/30/150/10	150
S1/20/200/8	200	S2/30/200/10	200
S1/20/250/8	250	S2/30/250/10	250
S1/20/300/8	300	S2/30/300/10	300
S1/20/350/8	350	S2/30/350/10	350
S1/20/400/8	400	S2/30/400/10	400
S1/20/450/8	450	S2/30/450/10	450

Element Ø25-Ø35, W = 30mm		Element Ø45-Ø55, W = 35mm	
Pattern	L	Pattern	L
S1/30/50/10	50	S2/35/50/12	50
S1/30/100/10	100	S2/35/100/12	100
S1/30/150/10	150	S2/35/150/12	150
S1/30/200/10	200	S2/35/200/12	200
S1/30/250/10	250	S2/35/250/12	250
S1/30/300/10	300	S2/35/300/12	300
S1/30/350/10	350	S2/35/350/12	350
S1/30/400/10	400	S2/35/400/12	400
S1/30/450/10	450	S2/35/450/12	450

Pattern Description: S1/30/400 = Type/Width mm (W)/Length mm (L)/ Tag Hole Ømm (ØD)
Other sizes available on request.

TYPE Q-BRAIDS

For all connections to Globar SR and Globar GS elements, and any element using Type G clamps.

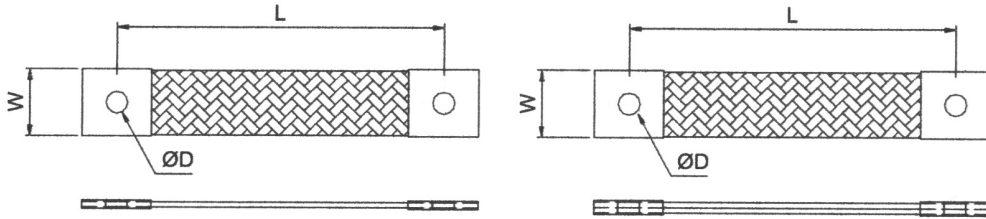

Element Ø10-Ø14, W = 10mm			Element Ø38-Ø45, W = 30mm	
Pattern	L	Price £	Pattern	L
Q1/10/50	50	0.78	Q1/35/50/10	50
Q1/10/100	100	1.01	Q1/35/100/10	100
Q1/10/150	150	1.16	Q1/35/150/10	150
Q1/10/200	200	1.31	Q1/35/200/10	200
Q1/10/250	250	1.54	Q1/35/250/10	250
Q1/10/300	300	1.77	Q1/35/350/10	300
Q1/10/350	350	2.01	Q1/35/350/10	350
Q1/10/400	400	2.24	Q1/35/400/10	400
Q1/10/450	450	2.48	Q1/35/450/10	450

Element Ø16-Ø22, W = 20mm			Element Ø38-Ø45, W = 30mm	
Pattern	L	Price £	Pattern	L
Q1/20/50	50	1.08	Q2/30/50	50
Q1/20/100	100	1.31	Q2/30/100	100
Q1/20/150	150	1.47	Q2/30/150	150
Q1/20/200	200	1.70	Q2/30/200	200
Q1/20/250	250	1.93	Q2/30/250	250
Q1/20/300	300	2.16	Q2/30/300	300
Q1/20/350	350	2.39	Q2/30/350	350
Q1/20/400	400	2.63	Q2/30/400	400
Q1/20/450	450	2.86	Q2/30/450	450

Element Ø25-Ø35, W = 30mm			Element Ø45-Ø55, W = 30mm	
Pattern	L	Price £	Pattern	L
Q1/30/50	50	1.63	Q2/35/50	50
Q1/30/100	100	1.86	Q2/35/100	100
Q1/30/150	150	2.09	Q2/35/150	150
Q1/30/200	200	2.32	Q2/35/200	200
Q1/30/250	250	2.63	Q2/35/250	250
Q1/30/300	300	2.94	Q2/35/300	300
Q1/30/350	350	3.24	Q2/35/350	350
Q1/30/400	400	3.56	Q2/35/400	400
Q1/30/450	450	3.86	Q2/35/450	450

Pattern Description: S2/35/400 = Type/Width mm (W)/Length mm (L)/ Tag Hole Ømm (ØD)
Other sizes available on request.

ALUMINIUM CONNECTING BRAIDS

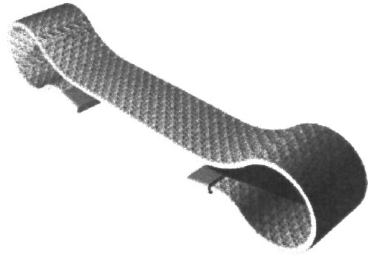

D1 Braid

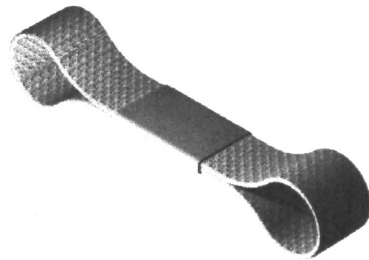

D2 Braid



S1 Braid

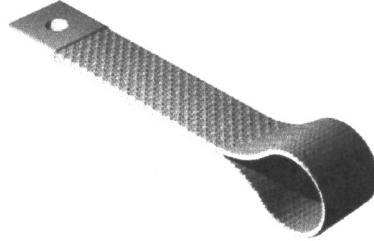

S2 Braid



Q1 Braid

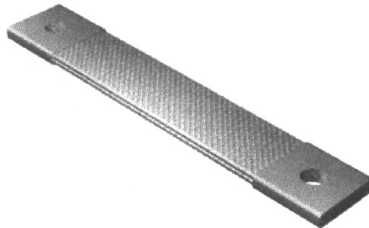

Q2 Braid

Braid Width	Rating
10mm	25A
20mm	50A
30mm	100A
35mm	150A